

fluorescent with frosted upright ring
fusion™



features

Pendant mount luminaire available in 1, 2, 3 and 4 lamp compact fluorescent.

Reflector with the frosted upright ring is a great solution for highlighting ceilings.

Fusion's™ refined appearance is a blend of highly tooled aluminum and precision die-cast components.

Ideally suited for retail, hospitality, lobbies, cafeterias, open ceiling areas and other specialty applications.

details



illuminated heat vent

options



frosted white upright ring



frosted blue upright ring



frosted white diffusion disk



frosted green diffusion disk

dimensional data

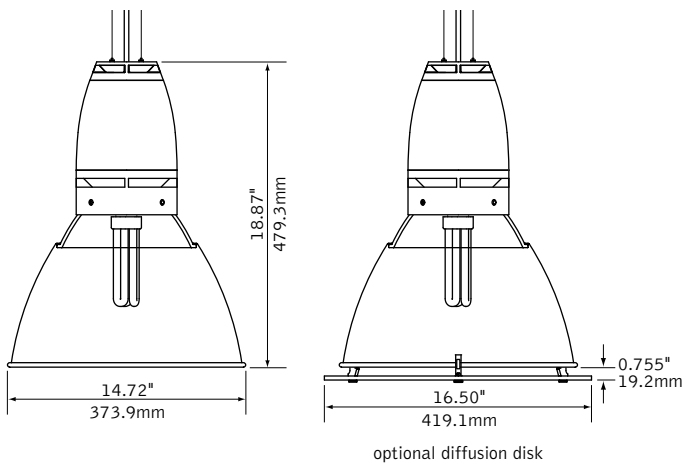

lamping options

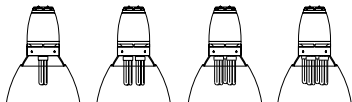

1, 2, 3 & 4 LAMP 32W & 42W TRIPLE TUBE

performance

1-Lamp 42W Triple Tube
 72% Efficiency
 751 cd @ 10°

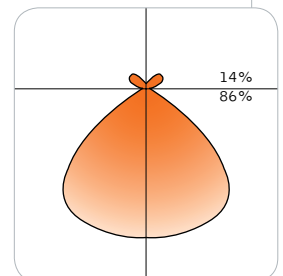

Visit focalpointlights.com for complete photometric data.

fixture:

project:

suspension information

suspension length is determined from ceiling to top of luminaire.
2-point aircraft cable with metal braided SJT cord.

standard suspension

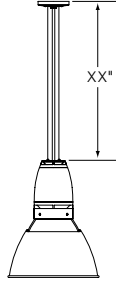

suspension with emergency battery pack

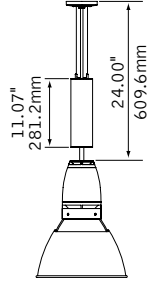

24" minimum suspension required from the ceiling to the top of the housing when using a emergency battery pack.

specifications

construction

Ballast enclosure constructed of 16Ga. spun aluminum center housing with die-cast ends.

Ballast bracket constructed of 20Ga. galvanized steel.

Reflector constructed of 16Ga. Spun aluminum, 14.72" Dia. and .235" thick frosted white borosilicate glass.

Emergency battery pack housing constructed of 16Ga. steel tube, 11"H x 3.5" Dia. and 16Ga. C.R.S. ballast bracket.

Canopy: 5" Dia. X .875"H., spun steel.

weight: 10 lbs

optic

16Ga., 3002-0 anodized aluminum reflector with low iridescent, matte anodized interior finish.

Optional frosted white or green acrylic diffusion disk with polished edges are retained by aluminum fasteners and (3) #8-32 thumb screws.

electrical

Luminaires are pre-wired for single circuit with thermally protected class "P" electronic ballast.

Factory installed decorative metal braided power cord is included. White SJT power cord supplied for Emergency circuit, dimming and 347 volt.

One, two, three or four lamp triple tube compact fluorescent, 4-pin, 32W (Gx24q-3), 42W (Gx24q-4).

Line voltage dimming available in 120 or 277 Volt.

Consult factory for specifications and availability.

finish

Luminaire reflector and housing are clear anodized with clear polished satin finish.

Castings finished in Bright Silver (BS).

Reflector interior has matte diffuse finish.

Die-cast housing caps finished in silver polyester powder coat applied over a 5-stage pre-treatment.

Canopies finished in Matte Satin White.

ordering

luminaire series FSN
Fusion FSN

profile _____
Reflector with Frosted Blue Uplight Ring RUB
Reflector with Frosted White Uplight Ring RUW

lamp quantity _____
One Lamp 1
Two Lamp 2
Three Lamp 3
Four Lamp 4

lamp type _____
32W Triple Tube, GX24q-3 32TT
42W Triple Tube, GX24q-4 42TT

circuit _____
Single Circuit 1C
Dual Circuit 2C
(Multiple lamp fixtures only)

voltage _____
120 Volt 120
277 Volt 277
347 Volt 347

ballast _____
Electronic Program Start<10% THD S
Electronic Dimming Ballast* D
(consult factory for dimming limitations)

suspension _____
24" Aircraft Cable C24
48" Aircraft Cable C48
96" Aircraft Cable C96

factory options _____
Emergency Battery Pack* EM
HLR/GLR Fuse FU
(one and two lamp only)
Frosted Green Diffusion Disk GD
Frosted White Diffusion Disk WD
Include 3000K Lamp L830
Include 3500K Lamp L835
Include 4100K Lamp L841

* for more information see Reference section.

fluorescent with frosted upright ring
fusion™

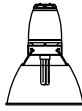

Filename: FSNRUW142TT.IES
 Catalog #: FSN-RUW-1-42TT-S-120-C24
 Efficiency: 72%
 Test #: 13064.0

CANDLEPOWER DISTRIBUTION

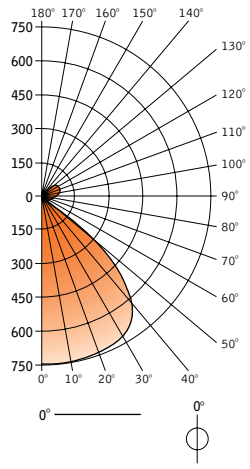

Spacing 1.5
 Criterion: 1.0

Vertical Angle	Horizontal Angle 0°	Zonal Lumens
0°	748	
5°	749	72
15°	750	213
25°	741	343
35°	714	449
45°	555	430
55°	265	238
65°	50	49
75°	22	23
85°	29	32
90°	37	
95°	50	54
105°	76	80
115°	94	93
125°	101	90
135°	89	69
145°	63	40
155°	36	17
165°	23	7
175°	19	2
180°	16	

LUMEN SUMMARY

Zone	Lumens	% Lamp	% Fixt
0°-30°	627	19.6	27.3
0°-90°	1848	57.7	80.3
90°-130°	318	9.9	13.8
90°-180°	452	14.1	19.7
Total Luminaire	2300	71.9	100.0

LUMINANCE DATA (CD/M²)

Vertical Angle	0°
45°	7444
55°	4385
65°	1110
75°	792
85°	3167

CO-EFFICIENTS OF UTILIZATION

Floor	80				70				50				30				10				00
Ceiling	70	50	30	10	70	50	30	10	50	10	50	10	50	10	50	10	50	10	50	10	00
Wall	82	82	82	82	79	79	79	79	72	72	66	66	66	66	60	60	60	60	60	60	58
RCR	0	1	2	3	4	5	6	7	8	9	10	10	10	10	10	10	10	10	10	10	10
1	76	74	71	69	73	71	67	65	62	60	58	55	54	51	48	46	43	41	38	36	34
2	71	66	63	59	68	64	58	59	54	55	51	51	48	46	43	41	38	36	34	32	30
3	66	60	55	51	63	58	50	54	48	50	45	47	43	41	38	36	34	32	30	28	26
4	61	54	49	45	59	52	44	49	42	46	40	43	38	36	34	32	30	28	26	24	22
5	56	49	43	39	54	47	38	44	37	41	35	39	33	32	30	28	26	24	22	20	18
6	52	44	38	34	50	43	34	40	32	37	31	35	30	28	26	24	22	20	18	16	14
7	48	40	34	30	46	38	30	36	28	34	27	32	26	25	23	21	19	17	15	13	11
8	44	35	30	26	42	34	26	32	25	30	24	28	23	22	20	18	16	14	12	10	8
9	41	32	26	23	39	31	22	29	21	27	21	26	20	19	17	15	13	11	9	7	5
10	38	29	24	20	36	28	20	26	19	25	18	23	17	16	14	12	10	8	6	4	2

Numbers indicate percentage values of

Go to www.focalpointlights.com for additional photometric data.