

lens verve™ IV

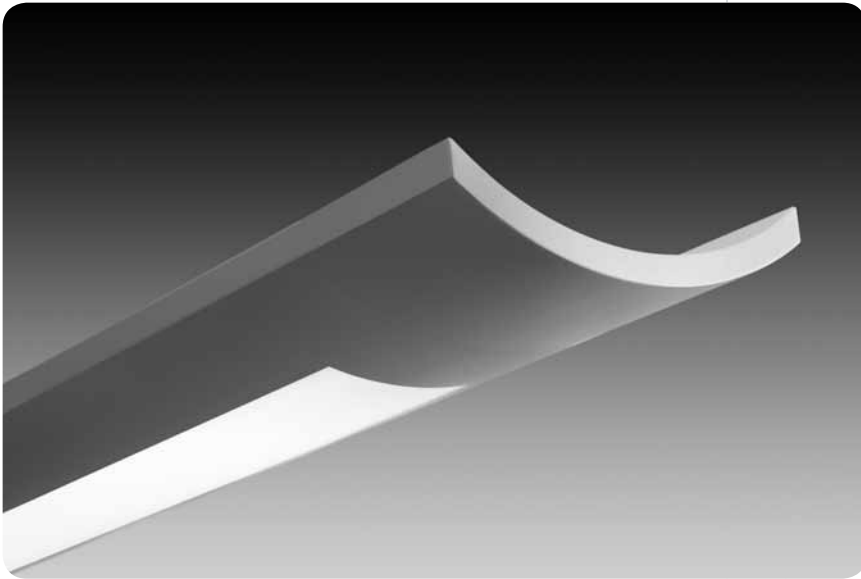

features

Suspended linear direct/indirect fluorescent with frosted acrylic, round patterned or squared patterned diffuser.

Standard distribution is 60% indirect/40% direct. Variable optics available.

One-piece steel housing with 5" die-cast end caps

3-lamp configurations offer optional CDR lamp separation with direct/indirect distribution from two outer lamps and direct only from center lamp. Specify PDR for total lamp chamber separation.

Practical and budget-friendly, Verve IV is an excellent choice for commercial and educational facilities.

dimensional data

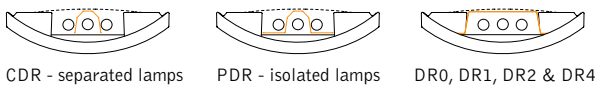
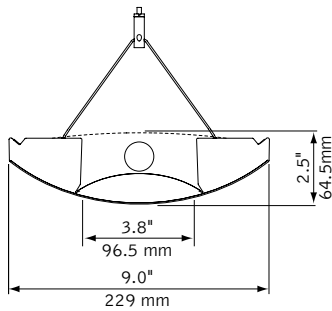

lamping options

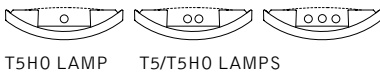

fixture information

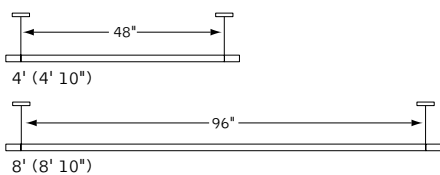

shielding options



sensor option companion luminaire

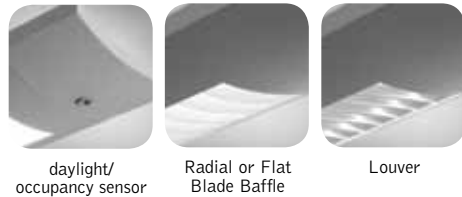

performance

2-Lamp T5
Frosted Acrylic Lens
96.5% Efficiency
1066 cd @ 155°

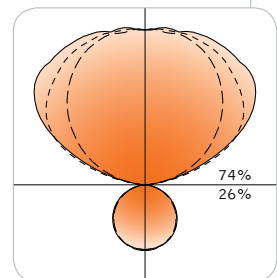

Visit focalpointlights.com for complete photometric data.

fixture:

project:

suspension information

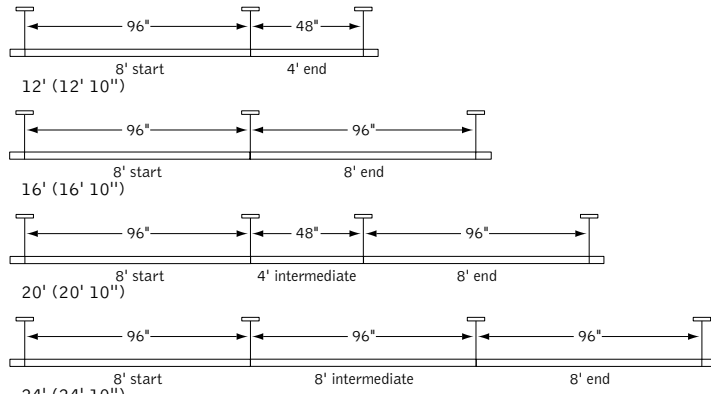

Consult factory for additional row length information.

specifications

construction

One-piece 20 Ga. steel housing.
 Die-cast 5" end cap fastened to housing.
 For row installation, internal brackets form hairline joint.
 Standard lengths are available in 4' and 8',
 All luminaires are provided with Y-cable suspension mounted on 48" or 96" centers.

4' unit weight: 20 lbs.
 8' unit weight: 30 lbs.

optic

Frosted Acrylic Diffuser is 0.20" thick.
 Patterned Acrylic Diffusers are 0.20" thick combined with additional 0.20" acrylic lens.
 Clear acrylic internal debris shield supplied standard.
 Optional Downlight Reflector optics fabricated of die-formed aluminum.
 PDR reflector isolates lamp chambers for fully indirect distribution from two outer lamps and fully direct from center.
 CDR separates lamps for direct/indirect distribution from two outer lamps and direct distribution from center.

electrical

Luminaires are pre-wired with factory installed branch circuit wiring and over-molded quick connects.
 Factory installed SJT power cord at feed location is included.
 Electronic ballasts are thermally protected and have a Class "P" rating.
 Optional dimming ballasts available.
 UL and cUL listed.

sensors

Lutron daylight sensor is a directional sensor that operates with a Lutron EcoSystem (DB) or H-Series (DK) ballast and controls system. The sensor has an integrated IR receiver for EcoSystem programming.
 Philips Luxsense daylight sensor measures reflected light from the surface below and dims lamp output when the light level exceeds required level. Output may be adjusted by turning the dial. A 0-10V dimming ballast is required (T5 - DS, T5HO - D7 standard).
 Wattstopper daylight sensor is a closed loop system that measures total light level from daylight and electric light. A 0-10V dimming ballast is required (T5 - DS, T5HO - D7 standard).
 Wattstopper occupancy sensor is a passive infrared sensor designed for cubicles and small offices. It has built-in daylight sensing that will hold lights off when adequate ambient light exists. One sensor controls multiple fixtures.

finish

Polyester powder coat applied over a 5-stage pretreatment.
 Canopy finished in Matte Satin White.

ordering

fixture series **FV4S**

Verve IV FV4S

shielding

Frosted Acrylic Diffuser AC
 Round Patterned Diffuser RA
 Square Patterned Diffuser SA

optional downlight accessories**

CDR- separated lamps CDR
 (3-lamp & dual circuit options only)
 PDR- isolated lamps PDR
 (3-lamp & dual circuit options only)
 100% downlight DR0
 up to 75% downlight DR1
 up to 60% downlight DR2
 up to 50% downlight DR4

lamplng

2 Lamp T5 2T5
 3 Lamp T5 3T5
 1 Lamp T5HO 1T5HO
 2 Lamp T5HO 2T5HO
 3 Lamp T5HO 3T5HO
 2 Lamp T8 2T8
 3 Lamp T8 3T8

circuit

Single Circuit 1C
 Dual Circuit (Multiple lamp luminaires only) 2C

voltage

120 Volt 120
 277 Volt 277
 347 Volt 347

ballast

Electronic Instant Start <20% THD (T8 Only) E
 Electronic Program Start <10% THD S
 Electronic Dimming Ballast* D

mounting

24" Cable Suspension C24
 48" Cable Suspension C48
 96" Cable Suspension C96
 (Specify "J" in place of "C" for 5" dia. canopies at power feed and 2" dia. canopies at non-feed locations)
 (Consult factory for sloped ceiling applications)

factory options

Dust Cover DC
 (Consult factory for compatibility)
 Emergency Circuit* EC
 Emergency Battery Pack* EM
 HLR/GLR Fuse FU
 Include 3000K Lamp* L830
 Include 3500K Lamp* L835
 Include 4100K Lamp* L841
 Lutron™ Daylight Sensor* LY1
 (EcoSystem/H-Series ballast & controls required)
 Lutron™ Sensor Feed* SF
 (EcoSystem ballast & controls required)
 Philips® Daylight Sensor* PY1
 (0-10V dimming ballast required)
 WattStopper™ Daylight Sensor* WY1
 (0-10V dimming ballast required)
 WattStopper™ Occupancy Sensor* WO1

finish

Matte Satin White WH
 Titanium Silver TS

luminaire length

4' 4'
 8' 8'
 12' (8'+4') 12'
 16' (8'+8') 16'
 20' (8'+8'+4') 20'
 24' (8'+8'+8') 24'

integrator options

90-degree Corner FV4-90

remotes

(specify quantity)
 WattStopper™ Daylight Setup Remote* WYSR
 (required for programming, one included per order)
 WattStopper™ Occupant Controller* WOR



* for more information see Reference section. **Lamp type will effect actual percentage values. See IES file for exact uplight/downlight %.

frosted acrylic lens
verve™ IV

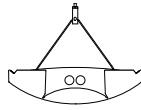

Filename: FV4SAC2T5.IES
Catalog #: FV4S-AC-2T5-1C-120-S-WH-4
Efficiency: 96.5%
Test #: 26371

CANDLEPOWER DISTRIBUTION

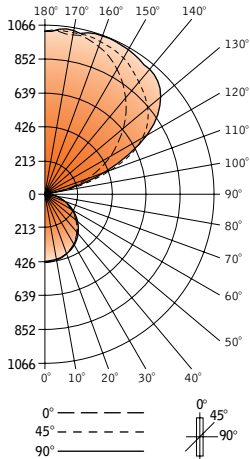

Vertical Angle	0°	22.5°	45°	67.5°	90°	Zonal Lumens
0°	433	433	433	433	433	
5°	435	432	431	432	429	42
15°	420	417	417	420	419	118
25°	390	389	390	393	393	180
35°	347	346	348	352	352	218
45°	292	292	295	299	299	228
55°	228	228	232	236	236	207
65°	159	159	164	167	168	161
75°	88	90	94	96	97	99
85°	24	25	33	38	40	36
90°	0	6	13	18	20	
95°	35	64	50	49	49	67
105°	212	328	305	374	361	301
115°	398	513	615	599	588	545
125°	567	655	797	860	873	674
135°	728	786	892	982	101	679
145°	859	890	964	1021	1044	599
155°	962	974	1018	1051	1066	468
165°	1023	1030	1043	1055	1061	294
175°	1036	1032	1044	1050	1050	101
180°	1035	1035	1035	1035	1035	

LUMEN SUMMARY

Zone	Lumens	% Lamp	% Fixt
0°-30°	339	6.5	6.8
0°-90°	1288	24.8	25.7
90°-180°	3728	71.7	74.32
Total Luminaire	5017	96.5	100.0

LUMINANCE DATA (CD/M²)

Vertical Angle	0°	45°	90°
45°	4044	4098	4155
55°	3890	3973	4047
65°	3669	3818	3894
75°	3322	3558	3692
85°	2638	3658	4485

CO-EFFICIENTS OF UTILIZATION

Floor	80	70	20	50	30	10	00
RCR 0	98	98	98	98	87	87	87
1	89	85	81	78	79	76	70
2	81	74	69	64	72	66	57
3	74	65	59	53	66	59	49
4	68	58	50	45	60	52	41
5	62	50	43	38	55	46	34
6	57	45	38	33	50	41	30
7	52	41	33	28	46	35	25
8	48	37	29	24	43	33	22
9	44	33	26	21	39	30	19
10	41	30	23	19	37	27	17

Go to www.focalpointlights.com for additional photometric data.

Numbers indicate percentage values of reflectivity.

frosted acrylic lens
verve™ IV

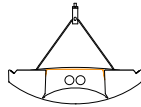

Filename: FV4SACDR02T5.IES
Catalog #: FV4S-AC-DR0-2T5-1C-120-S-WH-4
Efficiency: 44.1%
Test #: 26372

CANDLEPOWER DISTRIBUTION

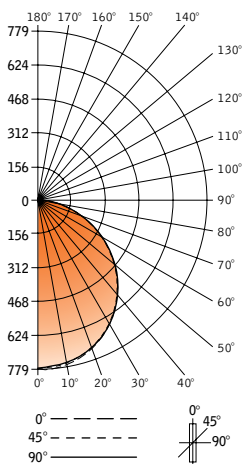

Vertical Angle	0°	22.5°	45°	67.5°	90°	Zonal Lumens
0°	775	775	775	775	775	
5°	779	772	770	771	767	74
15°	751	747	745	748	746	210
25°	697	695	693	696	695	320
35°	619	616	615	6158	617	385
45°	520	518	516	520	518	399
55°	404	401	402	405	403	359
65°	279	277	279	282	281	276
75°	151	151	156	159	161	164
85°	37	40	53	63	66	60
90°	0	9	22	32	35	
95°	2	1	6	12	14	9
105°	5	4	3	3	2	4
115°	7	6	6	5	4	5
125°	8	7	7	6	5	6
135°	8	10	9	8	7	7
145°	9	11	11	9	8	6
155°	10	13	13	12	10	5
165°	10	14	13	13	12	4
175°	10	12	13	13	13	1
180°	10	10	10	10	10	

LUMEN SUMMARY

Zone	Lumens	% Lamp	% Fixt
0°-30°	604	11.6	26.3
0°-90°	2248	43.2	97.9
90°-180°	47	0.9	2.1
Total Luminaire	2295	44.1	100.0

LUMINANCE DATA (CD/M²)

Vertical Angle	0°	45°	90°
45°	7187	7171	7200
55°	6882	6880	6907
65°	6450	6470	6528
75°	5726	5887	6091
85°	4153	4998	7483

CO-EFFICIENTS OF UTILIZATION

Floor	80	70	20	50	30	10	00
RCR 0	52	52	52	52	49	49	49
1	48	46	44	42	47	45	42
2	44	40	37	35	43	39	34
3	40	36	32	29	39	35	29
4	37	32	28	25	36	31	25
5	34	28	24	21	33	27	21
6	31	25	21	18	30	25	18
7	28	22	19	16	28	22	16
8	26	20	16	14	26	20	14
9	24	18	14	12	26	18	12
10	22	17	13	11	22	16	10

Go to www.focalpointlights.com for additional photometric data.

Numbers indicate percentage values of reflectivity.

frosted acrylic lens
verve™ IV

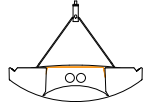

Filename: FV4SACDR12T5.IES
Catalog #: FV4S-AC-DR1-2T5-1C-120-S-WH-4
Efficiency: 56.2%
Test #: 26373

CANDLEPOWER DISTRIBUTION

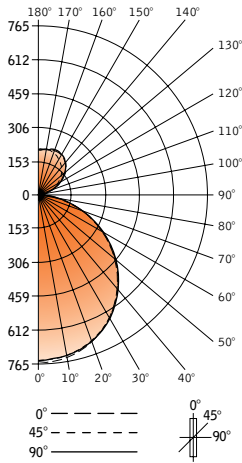

Vertical Angle	Horizontal Angle				Zonal Lumens
	0°	22.5°	45°	67.5°	
0°	762	762	762	762	762
5°	765	759	757	759	755
15°	738	734	733	737	735
25°	685	683	682	686	686
35°	608	607	606	610	609
45°	511	509	510	513	513
55°	398	395	397	400	401
65°	274	273	276	279	279
75°	149	150	154	158	160
85°	37	41	53	63	66
90°	0	9	21	31	34
95°	8	7	11	20	26
105°	44	48	42	38	43
115°	82	94	90	88	86
125°	117	134	137	133	130
135°	150	168	176	176	173
145°	177	188	201	205	204
155°	198	203	216	221	220
165°	210	211	217	220	220
175°	211	209	212	212	212
180°	210	210	210	210	210

LUMEN SUMMARY

Zone	Lumens	% Lamp	% Fixt
0°-30°	595	11.4	20.4
0°-90°	2218	42.7	76.0
90°-180°	702	16.5	24.0
Total Luminaire	2920	56.2	100.0

LUMINANCE DATA (CD/M²)

Vertical Angle	0°	45°	90°
45°	7065	7078	7123
55°	6783	6797	6861
65°	6349	6415	6493
75°	5627	5837	6073
85°	4126	5966	7445

CO-EFFICIENTS OF UTILIZATION

Floor	80			70			50			30			10			00		
Ceiling	70	50	30	10	70	50	10	50	10	50	10	50	10	50	10	50	10	00
RCR 0	64	64	64	64	61	61	61	55	55	50	50	45	45	45	45	43	43	43
1	58	56	53	51	55	53	49	48	45	44	42	40	38	36	36	36	36	
2	53	49	45	42	51	47	41	42	38	39	35	35	32	30	30	30	30	
3	49	43	39	35	46	41	34	38	32	34	30	31	28	26	26	26	26	
4	45	38	34	30	42	37	29	34	27	31	26	28	24	22	22	22	22	
5	41	34	29	24	38	32	25	30	23	27	22	25	20	19	19	19	19	
6	37	30	25	22	35	29	21	27	20	24	19	22	18	16	16	16	16	
7	34	27	22	19	33	26	17	24	18	22	16	20	15	14	14	14	14	
8	32	24	20	19	30	23	16	21	15	20	14	18	13	12	12	12	12	
9	29	2	17	14	228	21	14	19	13	18	12	16	12	10	10	10	10	
10	27	20	15	13	26	19	12	18	12	16	11	15	10	9	9	9	9	

Go to www.focalpointlights.com for additional photometric data.

Numbers indicate percentage values of reflectivity.

frosted acrylic lens
verve™ IV

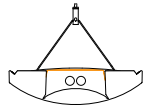

Filename: FV4SACDR22T5.IES
Catalog #: FV4S-AC-DR2-2T5-1C-120-S-WH-4
Efficiency: 56.4%
Test #: 26374

CANDLEPOWER DISTRIBUTION

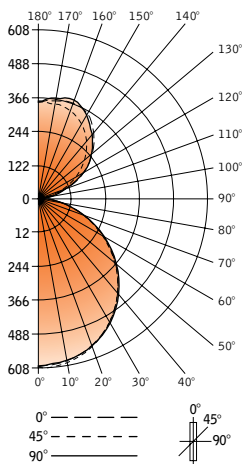

Vertical Angle	Horizontal Angle				Zonal Lumens
	0°	22.5°	45°	67.5°	
0°	605	605	605	605	605
5°	608	603	601	602	599
15°	586	583	582	585	583
25°	544	542	542	545	544
35°	483	481	481	485	485
45°	406	405	406	409	409
55°	316	315	318	320	320
65°	219	218	222	224	219
75°	120	120	125	128	129
85°	30	33	42	50	53
90°	0	8	19	29	35
95°	12	15	20	25	34
105°	67	85	74	67	79
115°	128	153	158	150	148
125°	188	220	224	224	195
135°	244	280	284	281	213
145°	291	317	334	330	201
155°	325	340	363	368	163
165°	345	353	364	371	102
175°	348	349	354	356	34
180°	347	347	347	347	347

LUMEN SUMMARY

Zone	Lumens	% Lamp	% Fixt
0°-30°	472	9.1	16.1
0°-90°	1769	34.0	60.3
90°-180°	1162	22.4	39.7
Total Luminaire	2931	56.4	100.0

LUMINANCE DATA (CD/M²)

Vertical Angle	0°	45°	90°
45°	5623	5635	5681
55°	5391	5438	5481
65°	5066	5156	5209
75°	4534	4719	4889
85°	3404	4779	5919

CO-EFFICIENTS OF UTILIZATION

Floor	80			70			50			30			10			00		
Ceiling	70	50	30	10	70	50	10	50	10	50	10	50	10	50	10	50	10	00
RCR 0	62	62	62	62	58	58	58	50	50	43	43	37	37	34	34	34	34	34
1	56	54	52	50	53	51	47	44	41	38	36	33	31	29	29	29	29	
2	51	47	44	41	48	44	39	39	34	34	30	29	26	24	24	24	24	
3	47	42	37	34	44	39	32	34	29	30	26	26	23	21	21	21	21	
4	43	37	32	29	40	35	28	30	25	27	22	23	20	18	18	18	18	
5	39	32	28	24	37	32	23	27	21	24	19	20	17	15	15	15	15	
6	36	29	24	21	34	27	20	24	18	21	16	18	14	13	13	13	13	
7	33	26	22	18	31	25	17	22	16	19	14	17	13	11	11	11	11	
8	31	23	19	16	29	22	15	20	14	17	12	15	11	10	10	10	10	
9	28	21	17	14	26	20	13	18	12	15	11	13	9	8	8	8	8	
10	26	19	15	12	25	18	12	16	11	14	9	12	8	7	7	7	7	

Go to www.focalpointlights.com for additional photometric data.

Numbers indicate percentage values of reflectivity.

frosted acrylic lens
verve™ IV

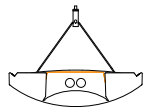

Filename: FV4SACDR42T5.IES
 Catalog #: FV4S-AC-DR4-2T5-1C-120-S-WH-4
 Efficiency: 71.3%
 Test #: 26375

CANDLEPOWER DISTRIBUTION

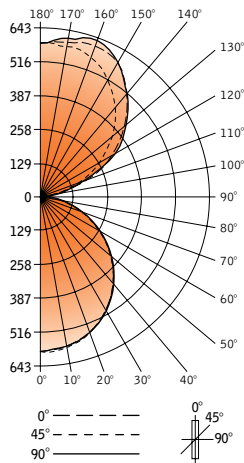

Vertical Angle	Horizontal Angle				Zonal Lumens
	0°	22.5°	45°	67.5°	
0°	600	600	600	600	600
5°	603	598	596	598	594
15°	581	578	577	580	579
25°	540	538	538	541	541
35°	479	478	478	482	482
45°	402	402	403	406	406
55°	313	312	316	318	318
65°	217	216	220	222	223
75°	118	119	124	126	130
85°	30	33	43	50	47
90°	0	7	16	23	26
95°	20	23	24	33	36
105°	110	139	123	104	129
115°	213	255	266	256	249
125°	311	368	373	380	389
135°	410	467	474	479	481
145°	489	532	565	564	562
155°	555	579	620	631	632
165°	593	603	623	638	643
175°	600	599	607	612	613
180°	600	600	600	600	600

LUMEN SUMMARY

Zone	Lumens	% Lamp	% Fixt
0°-30°	469	9.0	12.6
0°-90°	1756	33.8	47.3
90°-180°	1954	37.6	52.7
Total Luminaire	0°-180° 3710	71.3	100.0

LUMINANCE DATA (CD/M²)

Vertical Angle	0°	45°	90°
45°	5566	5595	5641
55°	5341	5403	5447
65°	5018	5121	5183
75°	4475	4695	4867
85°	3371	4784	5924

CO-EFFICIENTS OF UTILIZATION

RCR	Floor				Ceiling				Wall				
	70	50	30	10	70	50	30	10	70	50	30	10	
1	69	66	64	61	64	61	56	51	48	42	40	34	28
2	63	58	54	50	58	53	46	45	40	37	33	30	27
3	58	51	46	42	53	47	39	40	34	33	28	27	23
4	53	45	40	35	48	42	33	35	29	29	24	24	20
5	48	40	34	30	44	37	28	31	24	26	21	21	17
6	44	36	30	26	41	33	24	28	21	26	18	19	15
7	41	32	26	22	37	30	21	25	18	21	16	17	13
8	38	29	3	19	34	27	18	23	16	19	14	15	11
9	35	26	20	19	32	24	16	20	14	17	12	14	10
10	32	23	18	15	30	22	14	19	12	16	10	13	9

Numbers indicate percentage values of reflectivity.

Go to www.focalpointlights.com for additional photometric data.