

focus™ 3



features

High performance perimeter open wall washing system.

Luminaire alignment is maintained with continuous angle and splice brackets.

Focus™ 3 offers excellent vertical illumination without shielding.

dimensional data

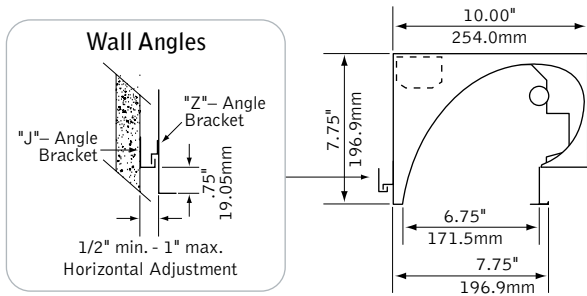

lamping options

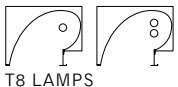

performance

1-Lamp T8
81% Efficiency
1437cd @ 15°

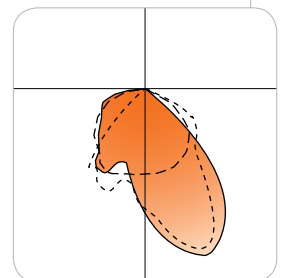

Visit focalpointlights.com for complete photometric data.

fixture:
project:

details

typical run layout

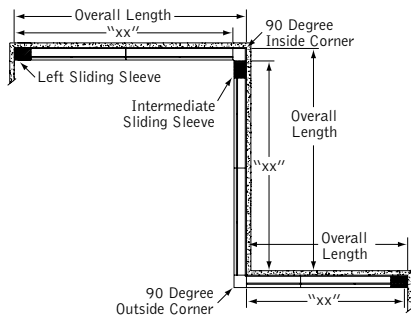

Luminaires must be installed prior to ceiling.
Start run from corner with any standard luminaire.
Corner to corner runs end with an intermediate sleeve.

sliding sleeves

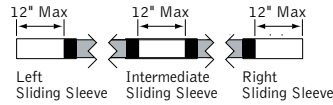

Fractional Dimensions up to 12" are taken up by the use of a sliding sleeve.
"J" and "Z" angle brackets must be cut to length in field.

specifications

construction

- 20 Ga. steel housing.
- 20 Ga. steel T-rail mates with ceiling.
- 18 Ga. internal bulkheads join luminaires.
- 18 Ga. galvanized steel splice brackets are provided to ensure precise luminaire alignment.
- 20 Ga. steel continuous wall angles are provided to ensure horizontal alignment at wall.
- Luminaires are available up to 8' nominal lengths.

4' unit weight: 36 lbs
8' unit weight: 49 lbs

optic

CNC roll-formed semi-specular .024" aluminum front reflector with specular .024" aluminum back reflector.

electrical

Electronic ballasts are thermally protected and have a Class "P" rating.
Optional dimming ballasts available.
Consult factory for dimming specifications and availability.
UL and cUL listed.

finish

Polyester powder coat applied over a 5-stage pre-treatment.
Standard luminaire housing finished in Matte Satin White.

ordering

luminaire series FW3
Focus 3 FW3

shielding NS
No Shielding, Open Optic NS

lamping
One Lamp T8 1T8
Two Lamp T8 2T8
One Lamp T5 1T5
Two Lamp T5 2T5
One Lamp T5HO 1T5HO
Two Lamp T5HO 2T5HO

circuit
Single Circuit 1C
Dual Circuit (Two lamps only) 2C

voltage
120 Volt 120
277 Volt 277
347 Volt 347

ballast
Electronic Instant Start <20% THD E
Electronic Program Start <10% THD S
Electronic Dimming Ballast* D

mounting RC
Recessed RC

factory options
Air Return AR
Emergency Circuit* EC
Emergency Battery Pack* EM
Flanged End (specify when run does not terminate at a wall) FL
HLR/GLR Fuse FU
Matte White Reflector WR
Include 3000K Lamp* L830
Include 3500K Lamp* L835
Include 4100K Lamp* L841
Sliding Sleeve SS

finish WH
Matte Satin White WH

luminaire length
Designate length in feet XX'
(Nominal lengths: 2', 3', 4', 5', 6', 7', 8')
(All end caps are flat with no flange unless otherwise specified)

corner options
90-degree Inside Corner FW3-IC90
90-degree Outside Corner FW3-OC90

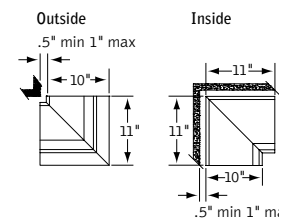

* for more information see Reference section.

focus™ 3

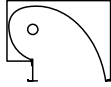

Filename: FW3NS1T8.IES
 Catalog #: FW3-1T8-1C-120-E-RC-HW
 Efficiency: 81%
 Test #: 8761.0

CANDLEPOWER DISTRIBUTION

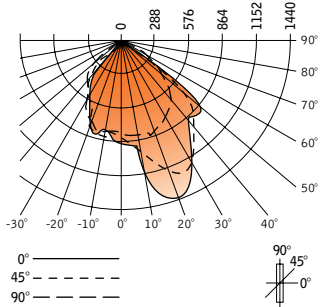

Vertical Angle	Horizontal Angle				Zonal Lumens
	0°	22.5°	45°	67.5°	
0°	1029	1029	1029	1029	1029
5°	1106	1100	1089	1074	1020
15°	1437	1393	1244	1087	996
25°	1334	1382	1399	1131	915
35°	775	883	1101	1125	772
45°	665	622	631	948	613
55°	344	417	497	584	420
65°	22	55	223	265	252
75°	7	12	16	94	97
85°	3	3	4	7	19
90°	0	0	0	0	0
95°	0	0	0	0	0
105°	0	0	0	0	0
115°	0	0	0	0	0
125°	0	0	0	0	0
135°	0	0	0	0	0
145°	0	0	0	0	0
155°	0	0	0	0	0
165°	0	0	0	0	0
175°	0	0	0	0	0
180°	0	0	0	0	0

LUMEN SUMMARY

Zone	Lumens	% Lamp	% Fixt
0°-30°	858	30.1	37.3
0°-40°	1394	48.9	60.5
0°-60°	2149	75.4	93.3
0°-90°	2303	80.8	100.0
Total Luminaire	2303	81	100.0

Go to www.focalpointlights.com for additional photometric data.

focus standard run length

Continuous Runs consist of standard fixture lengths. Left and Right End Trims and Sliding Sleeves are determinate, according to specific field conditions. Consult factory for details.

Example: 32' run = three 8' fixtures and one 7' fixture with a sliding sleeve expandable to 32'.

run length (in feet)	standard fixture lengths required	lamp sizes	sliding sleeve	run length (in feet)	standard fixture lengths required	lamp sizes	sliding sleeve
4-5	4	4	1	34-35	8 8 8 6 4	4 4 4 4 4 4 4 3 3	1
5-6	5	5	1	35-36	8 8 8 8 3	4 4 4 4 4 4 4 4 3	1
6-7	6	3 3	1	36-37	8 8 8 8 4	4 4 4 4 4 4 4 4 4	1
7-8	7	4 3	1	37-38	8 8 8 6 7	4 4 4 4 4 4 4 3 3 3	1
8-9	8	4 4	1	38-39	8 8 8 8 6	4 4 4 4 4 4 4 4 3 3	1
9-10	6 3	3 3 3	1	39-40	8 8 8 8 7	4 4 4 4 4 4 4 4 4 3	1
10-11	6 4	3 3 4	1	40-41	8 8 8 8 8	4 4 4 4 4 4 4 4 4 4	1
11-12	8 3	4 4 3	1	41-42	8 8 8 8 6 3	4 4 4 4 4 4 4 4 3 3 3	1
12-13	8 4	4 4 4	1	42-43	8 8 8 8 6 4	4 4 4 4 4 4 4 4 4 3 3	1
13-14	7 6	4 3 3 3	1	43-44	8 8 8 8 8 3	4 4 4 4 4 4 4 4 4 4 3	1
14-15	8 6	4 4 3 3	1	44-45	8 8 8 8 8 4	4 4 4 4 4 4 4 4 4 4 4 4	1
15-16	8 7	4 4 4 3	1	45-46	8 8 8 8 7 6	4 4 4 4 4 4 4 4 4 3 3 3	1
16-17	8 8	4 4 4 4	1	46-47	8 8 8 8 8 6	4 4 4 4 4 4 4 4 4 4 3 3	1
17-18	8 6 3	4 4 3 3 3	1	47-48	8 8 8 8 8 7	4 4 4 4 4 4 4 4 4 4 4 3	1
18-19	8 6 4	4 4 4 3 3	1	48-49	8 8 8 8 8 8	4 4 4 4 4 4 4 4 4 4 4 4 4	1
19-20	8 8 3	4 4 4 4 3	1	49-50	8 8 8 8 8 6 3	4 4 4 4 4 4 4 4 4 4 3 3 3	1
20-21	8 8 4	4 4 4 4 4	1	50-51	8 8 8 8 8 7 3	4 4 4 4 4 4 4 4 4 4 4 3 3	1
21-22	8 7 6	4 4 4 3 3 3	1	51-52	8 8 8 8 8 8 3	4 4 4 4 4 4 4 4 4 4 4 4 3	1
22-23	8 8 6	4 4 4 4 3 3	1				
23-24	8 8 7	4 4 4 4 4 3	1				
24-25	8 8 8	4 4 4 4 4 4	1				
25-26	8 8 6 3	4 4 4 4 3 3 3	1				
26-27	8 8 6 4	4 4 4 4 4 3 3	1				
27-28	8 8 8 3	4 4 4 4 4 4 3	1				
28-29	8 8 8 4	4 4 4 4 4 4 4	1				
29-30	8 8 7 6	4 4 4 4 4 3 3 3	1				
30-31	8 8 8 6	4 4 4 4 4 4 3 3	1				
31-32	8 8 8 7	4 4 4 4 4 4 4 3	1				
32-33	8 8 8 8	4 4 4 4 4 4 4 4 4	1				
33-34	8 8 8 6 3	4 4 4 4 4 4 3 3 3	1				