

# avenue a grid ceiling configurations

Avenue A is configured at our factory to integrate easily with your specified grid type, tile style and fixture position. Please review the below options and choose the mounting code that matches your application.

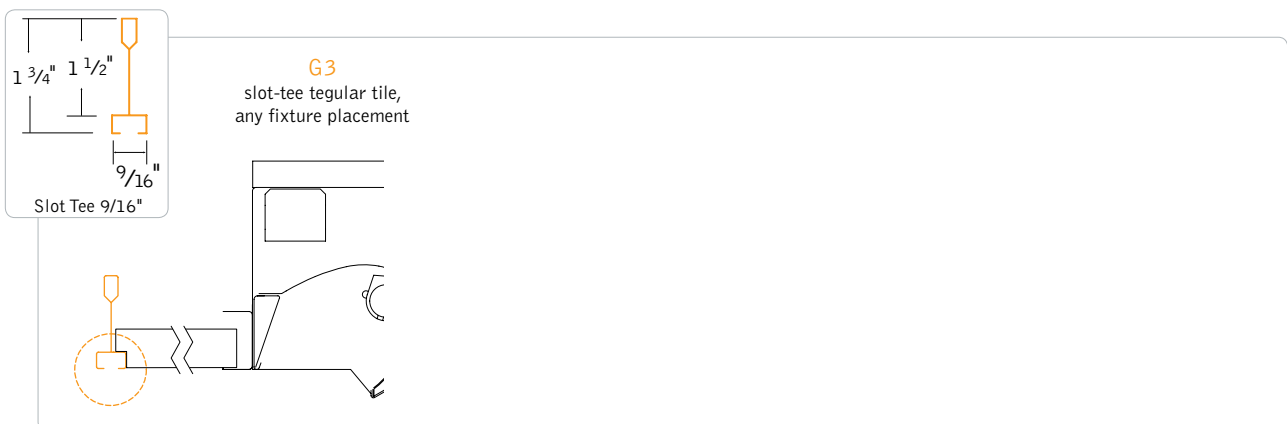

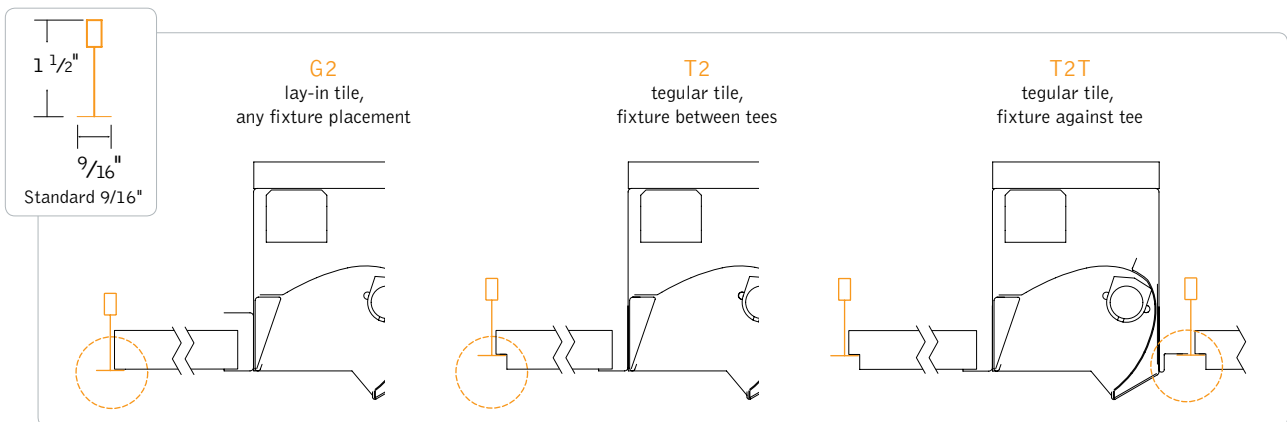
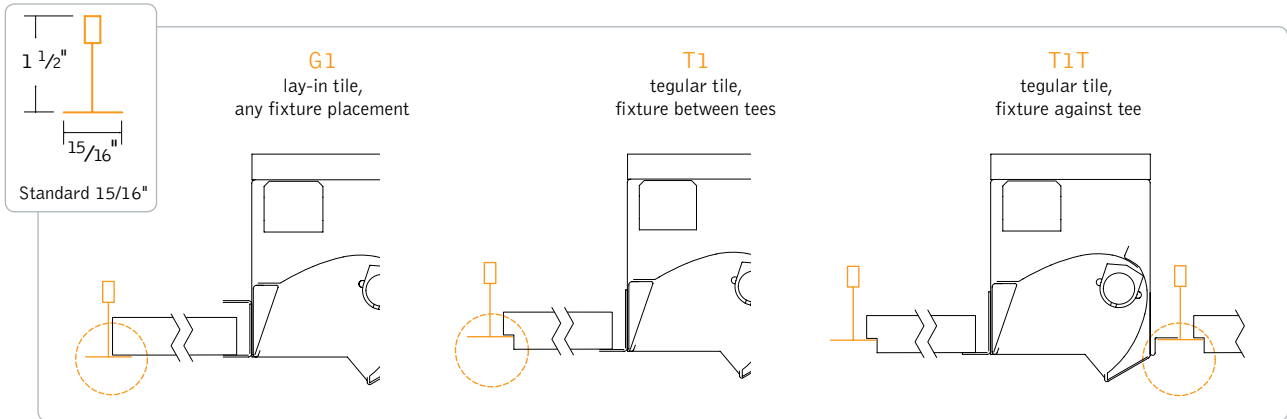
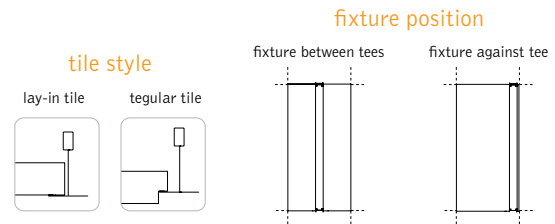
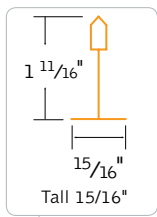

**G4**  
lay-in tile,  
any fixture placement

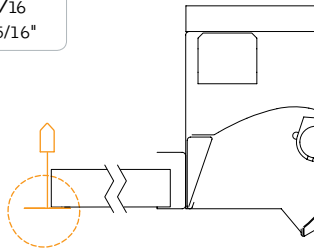

**T4**  
tegular tile,  
fixture between tees

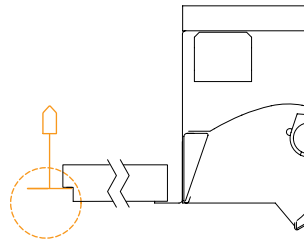

**T4T**  
tegular tile,  
fixture against tee

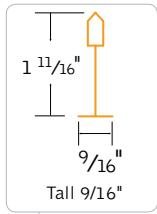
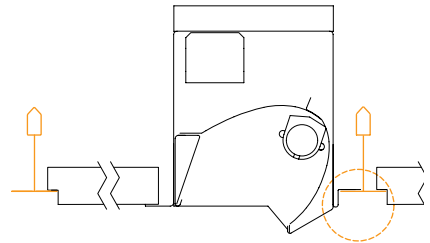

**G5**  
lay-in tile,  
any fixture placement

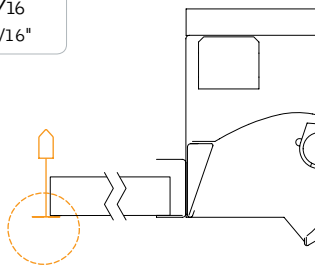

**T5**  
tegular tile,  
fixture between tees

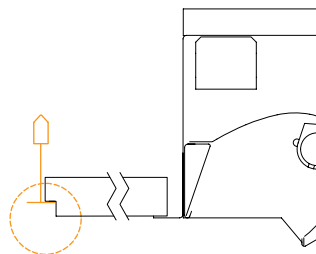

**T5T**  
tegular tile,  
fixture against tee

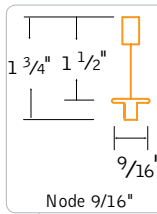
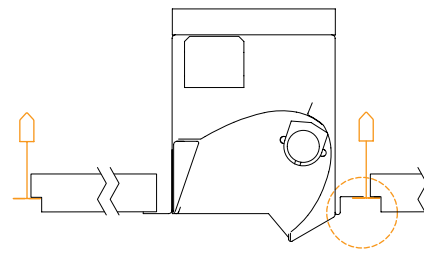

**T6**  
tegular tile,  
fixture between tees

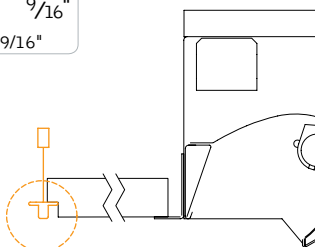

**T6T**  
tegular tile,  
fixture against tee

